

Programme's After Market Services NME-3 Series Transceivers

Service Tools

Contents

	Page No
Repair Place Cable SCD-2A	3
Flash Update Cable SCD-5	4
Adapter DAU-9S	5
SW Security Device "Dongle" PKD-1	6
Power Cable (FLA-7 to FPS-4) SCF-7	7
SIM Card Holder CAH-3	8
D9-D9 Cable AXS-4	9
D15-D15 Cable AXS-5	10
Service Test Box JBD-2	11
Flash Security Box TDF-4	12
Flash Loading Adapter FLA-7	13
Prommer Sales Package FPS-4S	14

Repair Place Cable SCD-2A

This cable is used between JBD-2 and CD949

Product Code : 0730171

View



Flash Update Cable SCD-5

This cable is used between CD949 and FLA-5 or FLA-7

Product Code : 0730170

View



Adapter DAU-9S

DAU-9S is connected between the phone and the serial (COM) port of the PC. It matches the M2BUS data bus signals to the serial data bus of the computer.

Product Code: 0730108

View

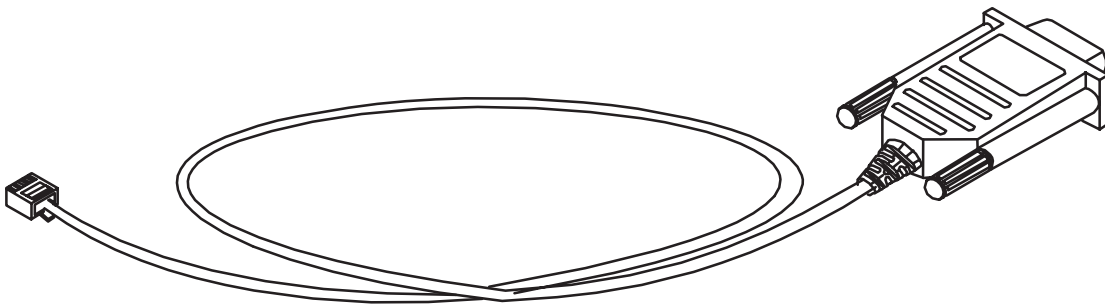

SW Security Device "Dongle" PKD-1

SW security device "Dongle" is a piece of hardware enabling the use of the service software when connected to the parallel (LPT) port of the PC. Without the dongle present it is not possible to use the service software. Printer or any such device can be connected to the PC through the dongle if needed.

Caution: Make sure that you have switched off the PC and the printer before making connections!

Caution: Do not connected the PKD-1 to the serial port. You may damage your PKD-1!

Product Code: 0750018

View

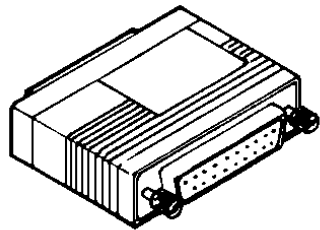

G0750018

Power Cable (FLA-7 to FPS-4) SCF-7

Function: Scf-7 is a power supply cable which connects FLA-7 and FPS-4.

Product Code : 0730141

View

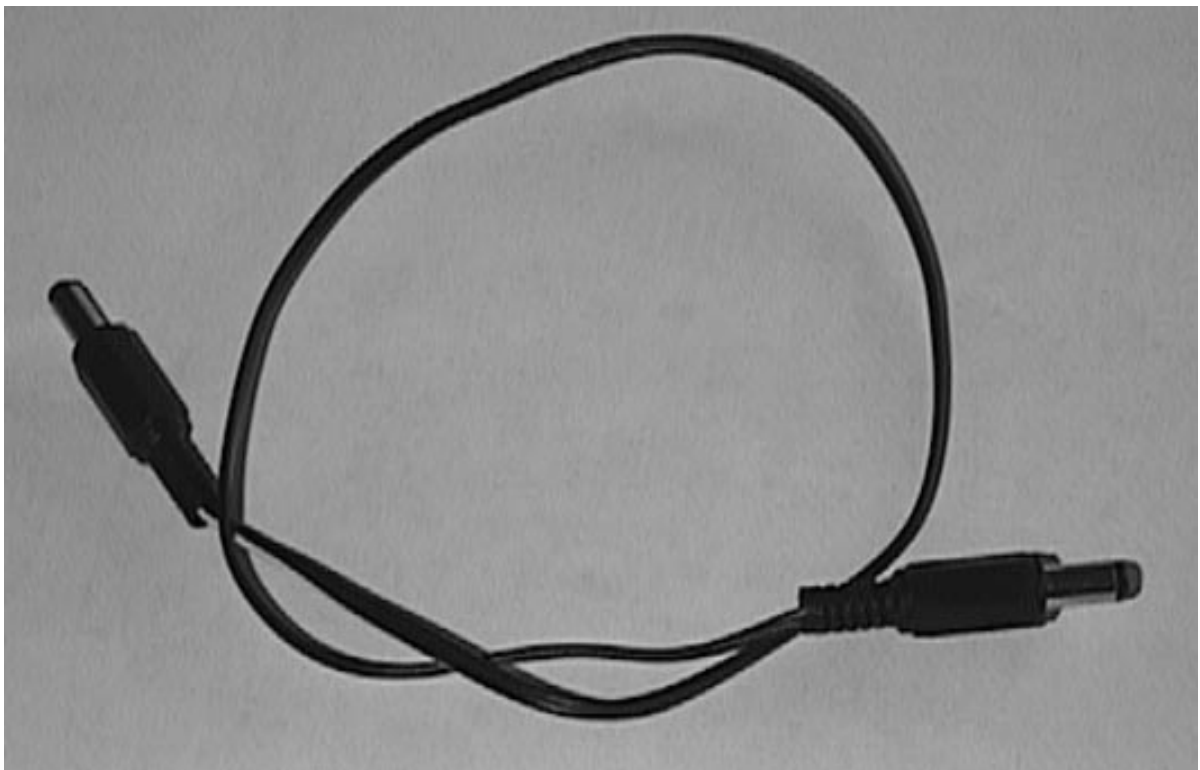

SIM Card Holder CAH-3

Function: CAH-3 holds a small SIM card while all mechanics are disassembled from the phone.

Make sure that the phone is switched off completely if you connect or disconnect the SIM card using this holder.

Product Code : 0750134

View

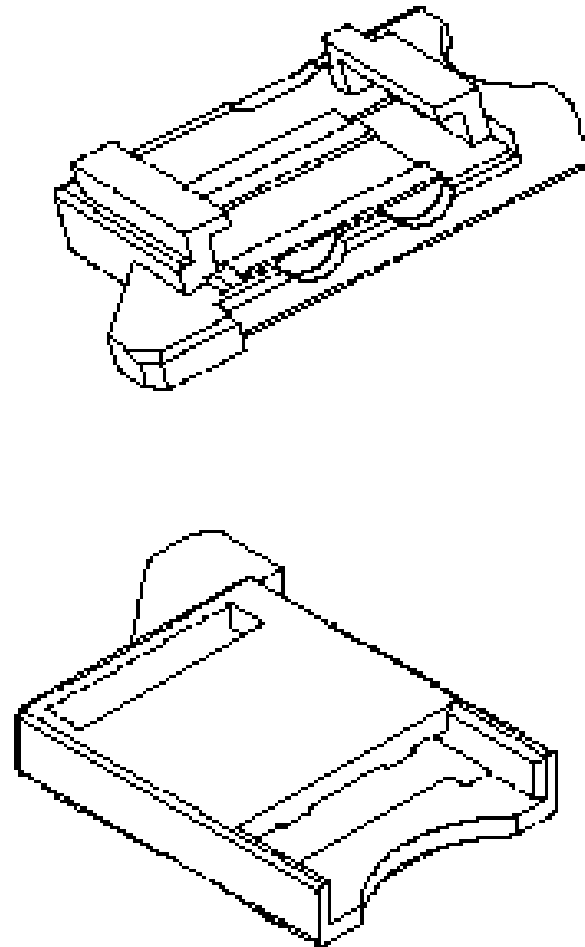

D9-D9 Cable AXS-4

Function: AXS-4 connects the phone to the testbox for a RS232 interface test.

Product Code : 0730090

View

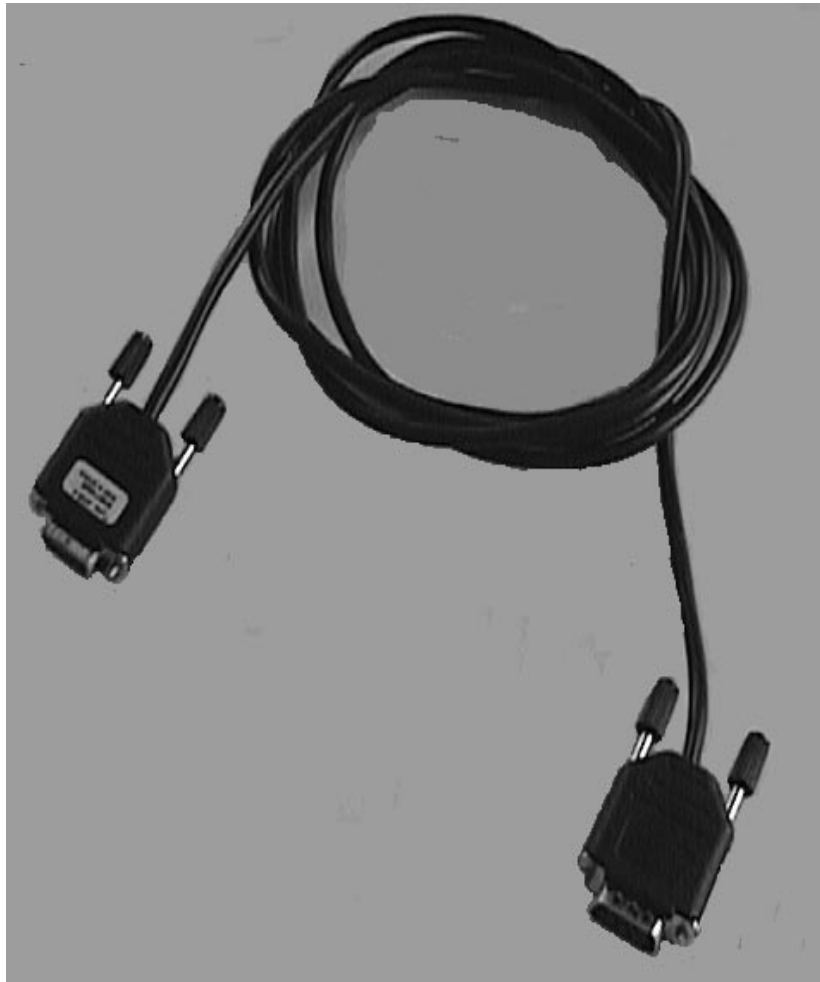

D15-D15 Cable AXS-5

Function: AXS-5 connects FPS-4 to FLA-7 in the "Flash Setup".

Product Code : 0730091

View



Service Test Box JBD-2

Used for testing, analysing and repairing both Radio Unit and Handset. A JBD-2 User Manual is included as a separate section of the Service Manual.

Product Code : 0770171

Front View

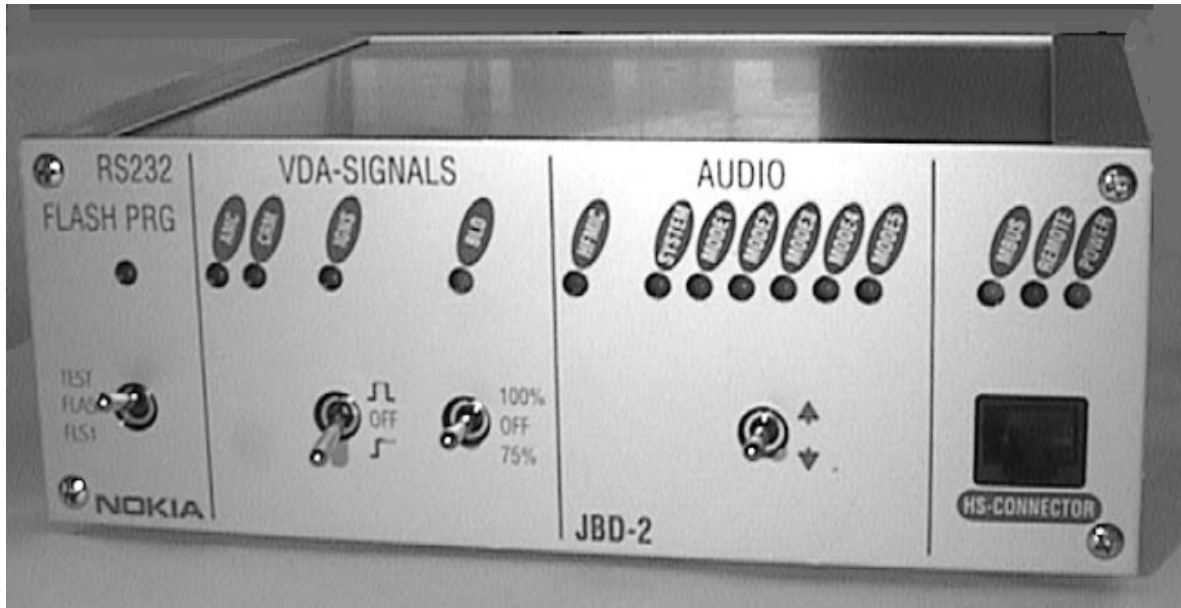

Back View



Flash Security Box TDF-4

Product Code : 0770106

Front View

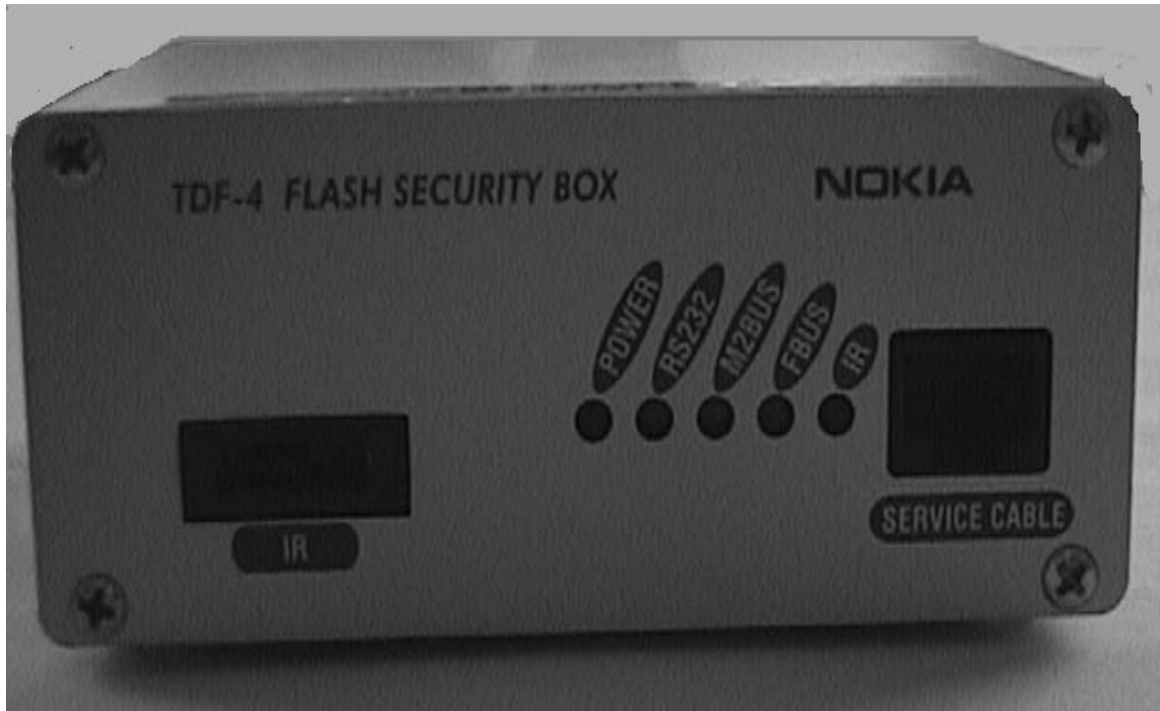

Back View

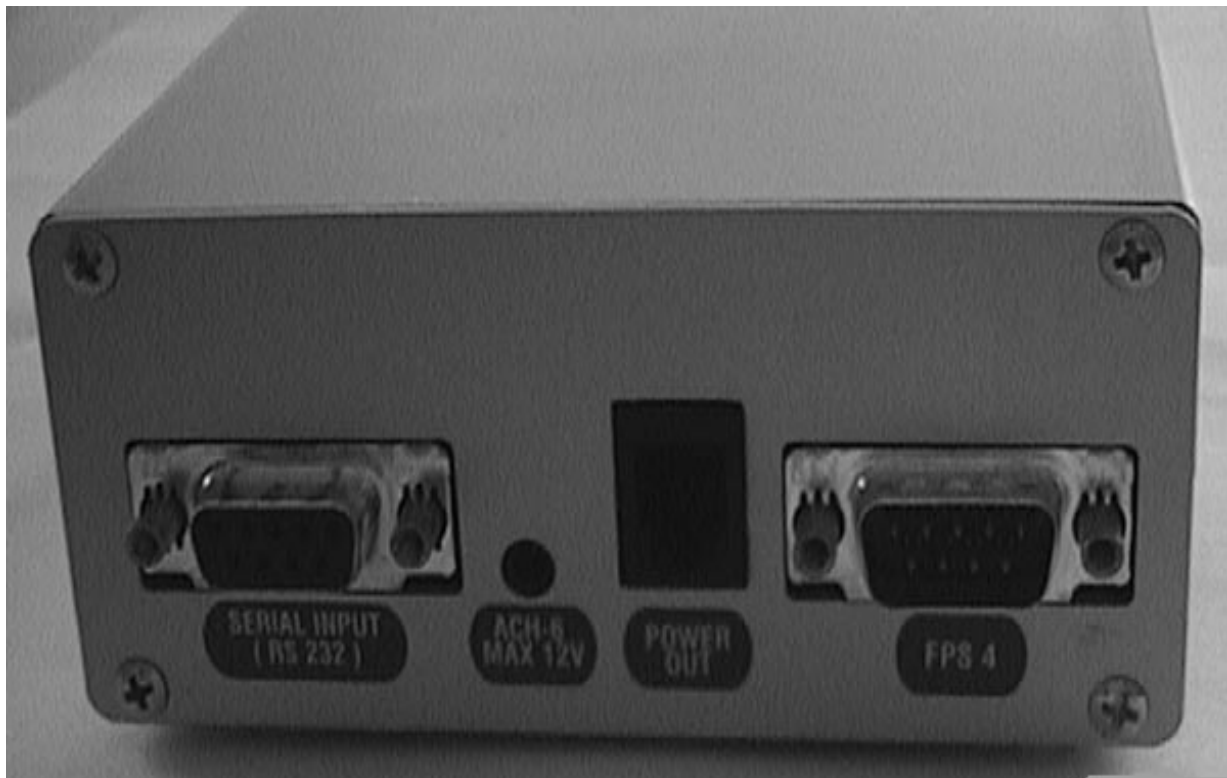

Flash Loading Adapter FLA-7

Product Code : 0770119

Front View



Back View



Prommer Sales Package FPS-4S

Product Code : 0085095

Front View



Back View

